

Article number: 2030100M2065A2X
 Description: E+G levelling foot
 GN 30-100-M20-65-A2-X
 Note: X With female thread, Wxternal hexagon

Measures

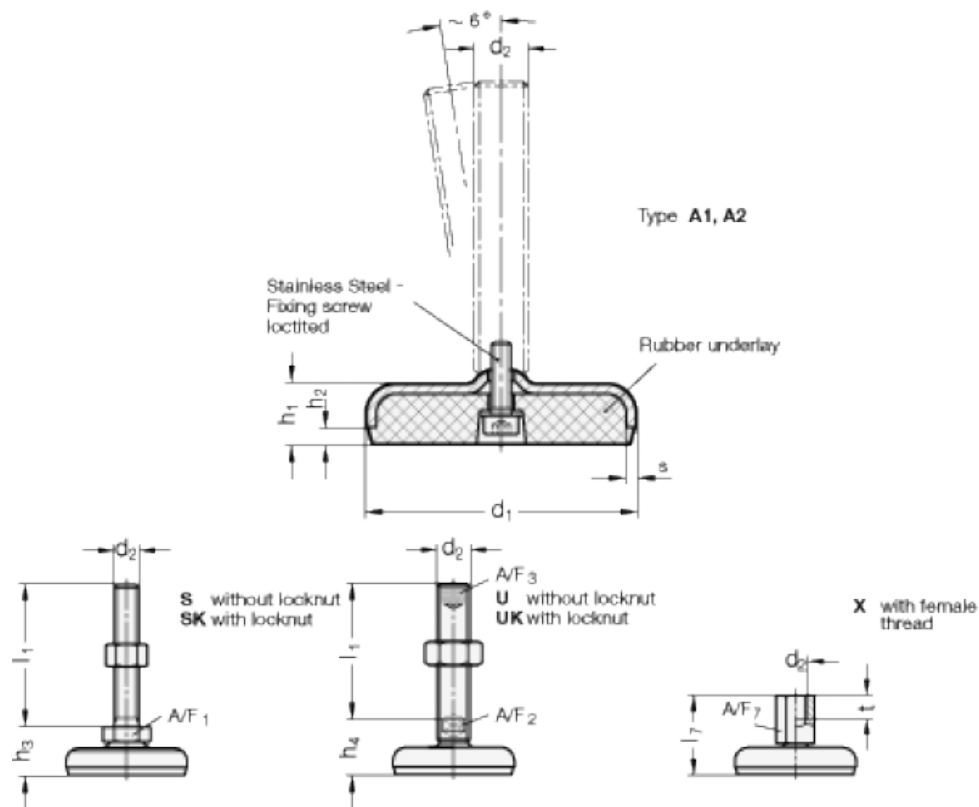

A/F7 = 27
 d1 = 100
 d2 = M20
 h1 = 22
 h2 = 6
 l7 = 65
 s = 3
 t = 20